

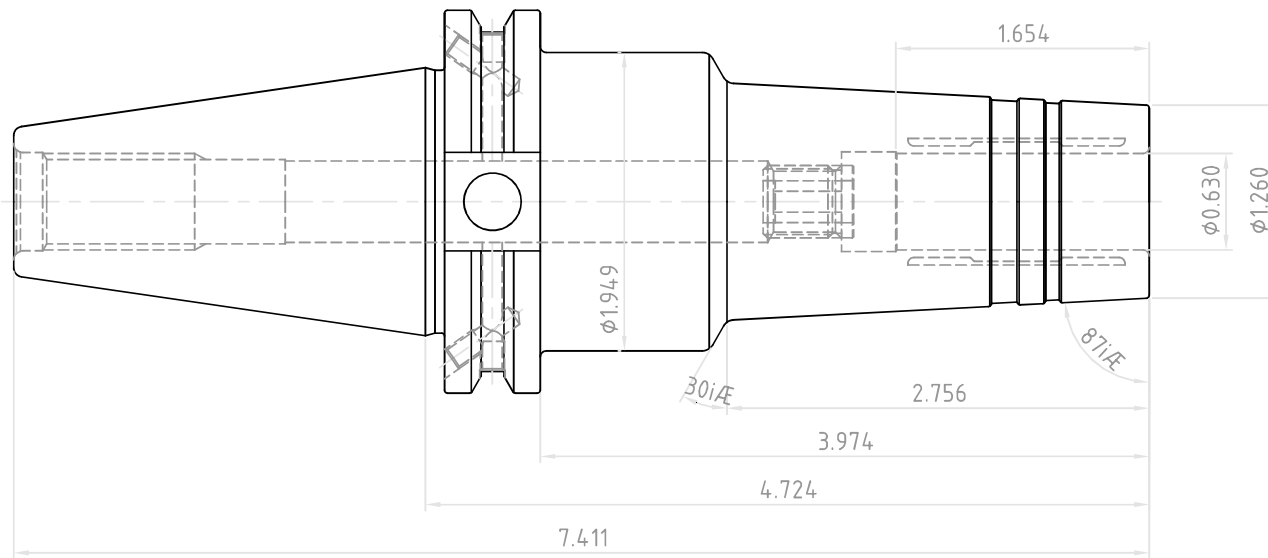

NO.	REVISIONS	DATE	DEVISER
1.			
2.			
3.			



 YG-1 CO., LTD.	DESCRIPTION		
	CAT40AD/B-HMC0.63(16)-4.72(120)		
	EDP No.	WK116HMC	SCALE 1 : 1