

NO.	REVISIONS	DATE	DEVISER
1.			
2.			
3.			

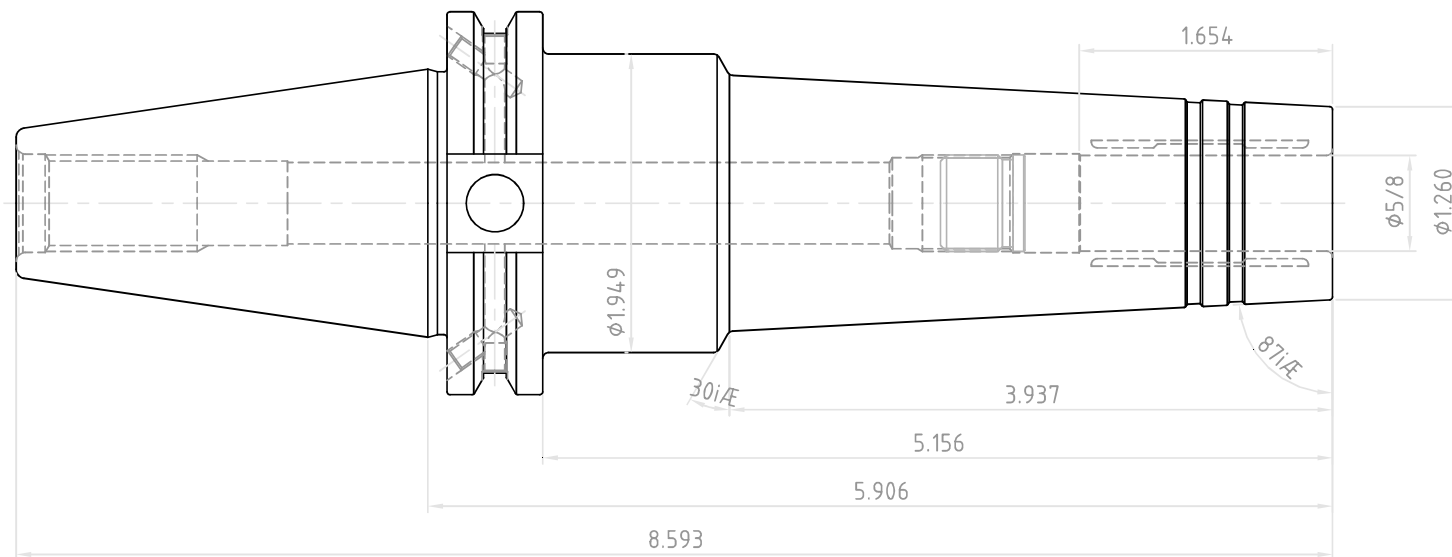

DESCRIPTION	
YG-1 CO., LTD.	CAT40AD/B-HMC5/8(15.87)-5.91(150)
EDP No.	WK038HMC SCALE 1 : 1