

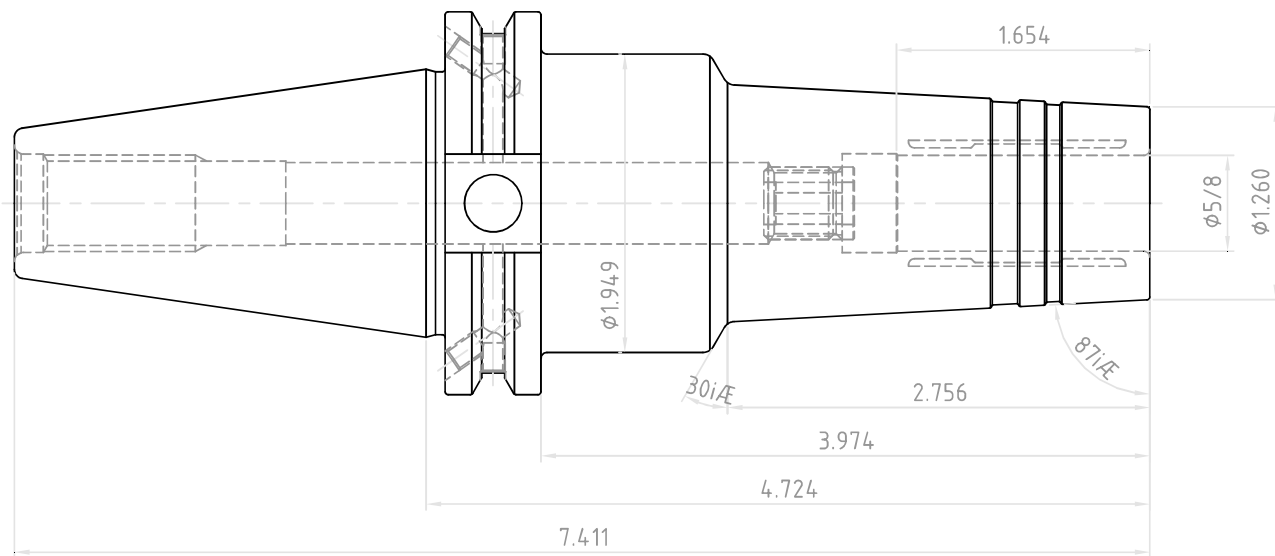

NO.	REVISIONS	DATE	DEVISER
1.			
2.			
3.			



 YG-1 CO., LTD.	DESCRIPTION	
	CAT40AD/B-HMC5/8(15.87)-4.72(120)	
	EDP No.	WK036HMC SCALE 1 : 1