

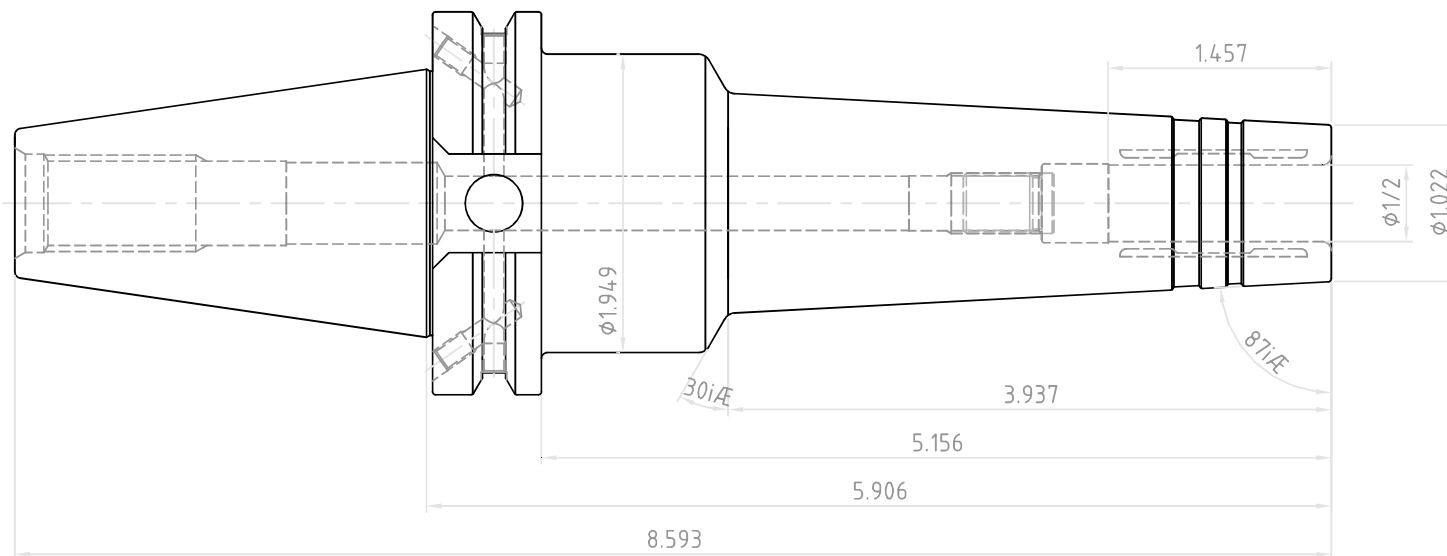

NO.	REVISIONS	DATE	DEVISER
1.			
2.			
3.			



 YG-1 CO., LTD.	DESCRIPTION	
	CAT40AD/B-HMC1/2(12.7)-5.91(150)	
	EDP No.	WK034HMC SCALE 1 : 1