

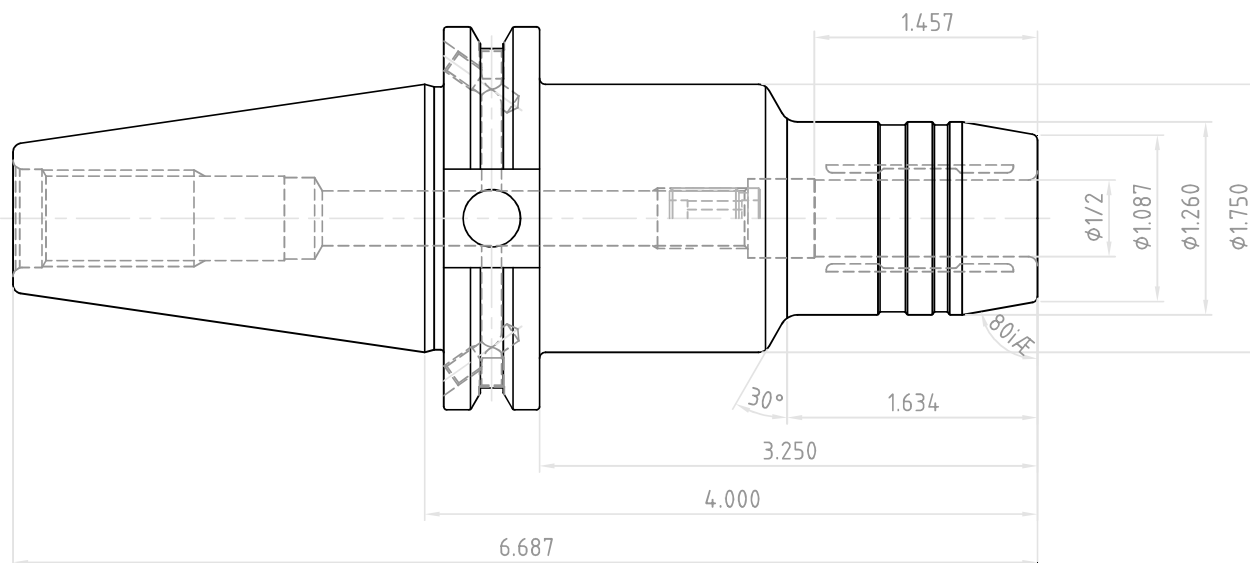

NO.	REVISIONS	DATE	DEVISER
1.			
2.			
3.			



 YG-1 CO., LTD.	DESCRIPTION	
	CAT40AD/B-HC1/2(12.7)-4(101.6)	
	EDP No.	WK024
	SCALE	1 : 1