

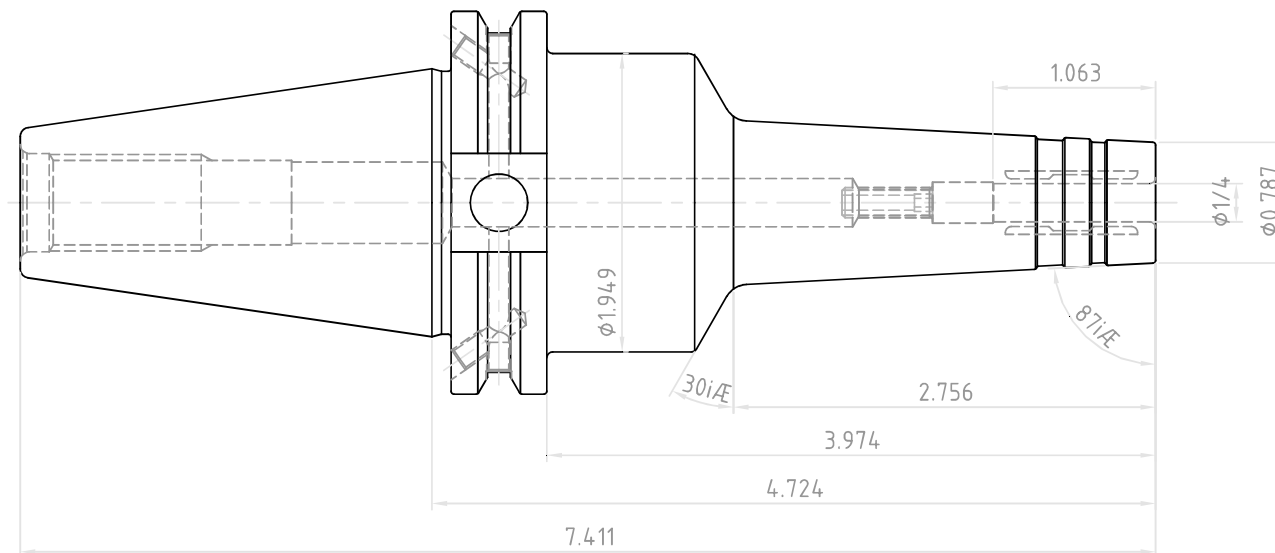

NO.	REVISIONS	DATE	DEVISER
1.			
2.			
3.			



		DESCRIPTION
 YG-1 CO., LTD.	CAT40AD/B-HMC1/4(6.35)-4.72(120)	
	EDP No.	WK020HMC SCALE 1 : 1